

The Design Explorer

The Ashlar-Vellum User Newsletter

Third Quarter, 2014

Newell Teapot at the Computer History Museum



While in California last month, Ashlar-Vellum owners Robert and Julie Bou visited the Computer History Museum in Mountain View (near San Jose) where they were privileged to see the actual Utah Teapot used by computer graphics pioneer and Ashlar founder, Martin Newell.

While working at the University of Utah, Newell purchased the famous German-made teapot at a local department store and used it as a reference model in 1975 to create a dataset of mathematical coordinates. From that he generated a 3D wireframe defining the teapot's shape, adding a surface skin.

For 20 years, programmers used Newell's teapot as a starting point, exploring techniques of lighting, shadowing and texturing to add depth and realism. The actual teapot is skinnier than many of its computerized images because the data was created for the rectangular pixels of early computer displays.

From the work on the teapot's original dataset, Martin Newell went on to develop Vellum® software and found Ashlar, Incorporated in 1988 with funding from venture capitalists Hambrecht & Quist. In 2005 Vellum Investment Partners acquired selected assets from Ashlar Incorporated.

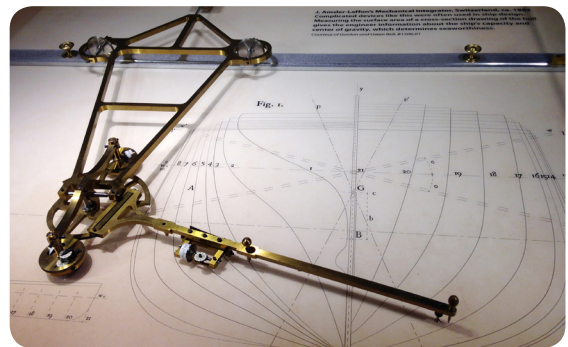

Also at the Computer History Museum was Laffon's Mechanical Integrator used in ship design to measure the surface area of a cross-section drawing of the hull. It helped determine the ship's capacity, centre of gravity and seaworthiness.

Museum staff demonstrated a working clone of Charles Babbage's Difference Engine. Built faithfully in 2002 from Babbage's original 19th-century design, this first computing engine has 8,000 parts, and is 11 feet long.

Graphite™ v9 SP1 R0



Build 9.2.2 of Graphite v9 SP1 was released in August. In addition to a number of bug fixes, including restoring the Midpoint Line tool, this release addresses issues with the German and Japanese language builds, and added the Graphite Quick Reference Card to the Help menu.

To download the latest release, from within Graphite v9, go to **Help>Check Web for Updates**.

To upgrade:

- From Graphite v8 to v9 for **US \$245** [click here](#)
- From Graphite v7 to v9 for **US \$695** [click here](#)

For a complete list of Graphite v9 enhancements, visit our [What's New in Graphite v9](#) page on the website.

Dieline Genius™ 3D & Folding Genius™ 3D for AI Released

AlphaCorr™ in association with Ashlar-Vellum released two new products this quarter.

The Dieline Genius 3D plug-in for Adobe Illustrator instantly creates precise die lines for packaging and point-of-purchase displays, then generates a folded 3D PDF file with the user's graphics. Utilizing a library of over 500 proven resizable designs, DLG 3D runs directly within the latest versions of Adobe Illustrator including Creative Suite 4, 5 and 6, Creative Cloud and Create Cloud 2014 on both Mac and Windows.

Dieline Genius 3D is only available as a subscription service and runs:

- US \$195/month
- US \$495/quarter
- US \$1,495/year

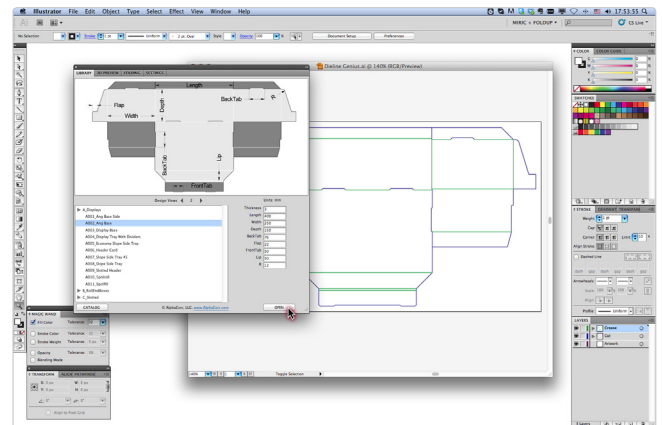
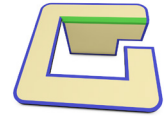

The Folding Genius 3D plug-in for Adobe Illustrator is intended for AI users who don't need dielines but do need 3D folding visualization of their files. Folding Genius 3D for AI is available as a subscription service for:

- US \$29.95/month
- US \$79.95/quarter
- US \$195/year.

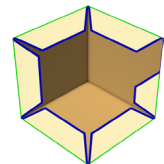

No permanent license is available since all Adobe products are now subscription-only.

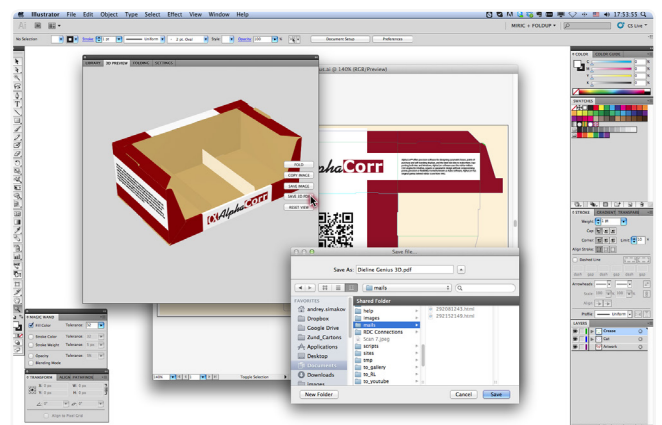

Graphite in the Cloud

Ashlar-Vellum realizes that some customers desire to use our software on an as-needed basis. Toward that end we are now beta testing Graphite v9 running in the cloud through Mainframe2 cloud services. Mainframe2 allows desktop applications to run virtually and be accessed from a browser without needing a plug-in. Mainframe2 uses Amazon web services, making it nearly infinitely scalable. File access is coordinated through any synchronized cloud storage account such as Microsoft OneDrive, Google Drive or Dropbox. We're awaiting the opening of Mainframe2 app store shortly to begin selling Graphite services. Prices for on demand use of Graphite are anticipated to start at about \$1/hour.

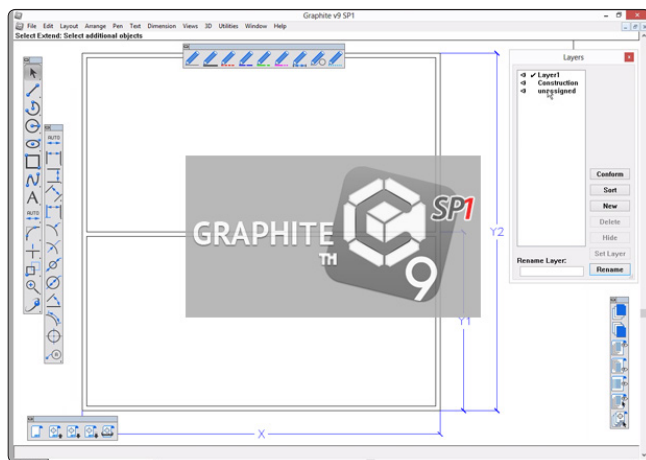

Graphite v9 in the cloud through Mainframe2.

MAINFRAME2

One Australian user is evaluating this setup now with an eye toward thousands of their customers using it only a couple of hours per month for estimating and ordering specialty construction materials.

Student Rental Licensing

Ashlar-Vellum recognizes the value of nurturing young innovators of design. Our Student/Teacher Unit one-year rental licensing is offered for:

- Classroom or lab situations.
- Instructors actively using our software to teach design.
- Students.

One-year STU rentals are priced as follows:

- [Cobalt v8 Plus](#) (including companion Graphite v9) **US \$115.00**
- [Xenon v8 Plus](#) (including companion Graphite v9) **US \$95.00**
- [Argon v8](#) **US \$50.00**
- [Graphite v9](#) **US \$75.00**

Active student users must verify their eligibility at time of rental and sign the [STU pre-ship agreement](#) found on our website.

This license is not intended for faculty members outside the design disciplines wanting CAD software for research or other projects. Nor is it for the business of the university such as facilities management. Both of these are covered under our [Research/Charitable/Retired](#) licensing.



CAD & 3D Modeling Special-use Licensing

Home → Shop → Special-use Licensing

Our Special-use Policies for CAD & 3D Modeling Software

In support of educational institutions and charitable organizations worldwide, we provide low-cost CAD and 3D modeling licensing options for classrooms, teachers and students; individuals working in academic research or for charities, and for fully retired individuals.

Research/Charitable/Retired (RCR)
This special-use software license of any of our CAD or 3D modeling programs is for non-profit academic institutions with professors and paid graduate students doing CIVILIAN research. It is also for academic institutions using it internally, such as a maintenance engineer employed by a university using it for facilities management. Our RCR license also covers other charitable and non-profit organizations such as hospitals, churches, and arts organizations including museums and theaters. We offer this special license price to individuals who are FULLY retired from all gainful employment, over 65 years old, and doing non-commercial design work only.

Please note that this license does NOT cover anyone doing research or development for a military industrial complex, such as many national labs, governed by large universities that are doing defense work. These organizations MUST purchase a full commercial license.

Your order must be accompanied by a signed RCR pre-ship agreement for each end user, and for charitable organizations, proof of your non-profit status, such as a 501(c)3 form from the Internal Revenue Service. These may be faxed to your VAR or directly to Ashlar-Vellum at +1 512 250-5811.

Research/Charitable/Retired

- RCR Cobalt Version 8
- RCR Xenon Version 8
- RCR Argon Version 8
- RCR Graphite Version 9

Student/Teacher Units

- STU Cobalt Version 8
- STU Xenon Version 8
- STU Argon Version 8
- STU Graphite Version 9

Shop our Web Store

Buy full materials or just the e-only download. Either way you can be working quickly.

Sales Around the World

Ashlar-Vellum Job Board

The [Ashlar-Vellum job board](#) now has resumes of people and postings of assignments around the world for full time, part time, freelance or contract jobs. Designers can work on site or remotely as necessary.

Looking for experienced people to help fill a design need? Check out the resumes or post a job description for someone you seek to hire.

Need a job? Post your resume on our site, then look at the latest job listings. You may find just the work you'd like.

Ashlar-Vellum seeks to develop a community of users offering opportunities and resources around the globe.

User Tip: Controlling Print Area for PDF in Graphite

When designating the print/export area for a drawing in Graphite, while using the **Layout->Drawing Size** tool, if **Printing** is selected the black boundary box will easily move when dragged by the mouse. But the green boundary box does not seem to move when **PDF Exporting** is specified. Tip: Hold down the Shift key when using the mouse to move the green boundary box designating the PDF export area.

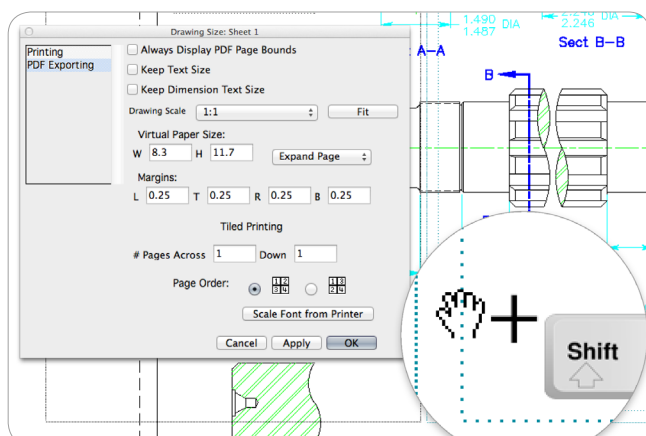

Congratulations Rio 21

IDEA/Brazil, the Brazilian division of IDSA has given Celso Santos and Christian Albanese a bronze award for the innovative design of a *Frescobol* racquet. *Frescobol*, or beach racquetball, was developed in the Copacabana area of Rio de Janeiro in the middle of the last century. Traditionally, wood or fiberglass racquets were used. But Rio 21 has designed an innovative racquet made of plastic. The head and edges are injected with soft rubber. The result is stylish, lightweight and tough. Textures in the grip allow perfect handling even when wet. Santos and Albanese use CobaltTM CAD and 3D modelling software to develop outstanding consumer products. Look for a more complete success story in a future edition of *The Design Explorer*.

Raquete Rio 21 Design



Mud, Snow, Sand, Meet Technology



Trey Hermann's creative impetus for starting Pronghorn Overland Gear came from his need for a bumper for a 1989 Toyota Land Cruiser. He found everything available came in steel, was ugly and very heavy. An experienced industrial designer, Hermann knew that when engineered and fabricated correctly, aluminium was a much better solution. He started designing the bumper using Cobalt™ CAD and 3D modelling software. Soon, one friend after another asked him to build one for their truck. After about the fourth, Hermann realized he had a viable business idea.

A traditional steel off-road bumper, weighing in at roughly 300 pounds (135 kilos), greatly affects the fuel economy, braking, acceleration, handling and off-road performance of a relatively light vehicle like a 4200 pound (1900 kilo) Jeep. Reducing the weight was a major consideration for Pronghorn's design team. He tells us:

"Using Cobalt and our engineering staff we've been able to go in and very easily optimize the designs and remove material where we don't need it. It's enabled us to very easily visualize where we are over-engineering our product and to take out material where it's simply not doing any good."

Made of optimally-engineered aluminum, the Pronghorn bumpers are not to be confused with a flimsy soda can. When aluminum is properly designed, it is strong and light just like an aircraft.

Pronghorn's first product to market is the Modular Front End System for the Jeep JK. This is a front bumper system available in 18 different configurations. Starting with either a standard full width or stub outer bumper (preferable with large diameter tires) the options include grill guards, headlight guards, skid plate, winch mounts, rotatable shackles and other goodies. Made of 6061-T6 and 7057-T6 aluminium, the lightest Pronghorn bumpers start at only 42 pounds (19kg) and with all the options will weigh only about 98 lbs (45kg), less than half the weight of the comparable steel bumper.

The Pronghorn modular aluminum bumper system has a number of competitive advantages in addition to improved handling. The first is shipping costs. A similarly configured product in steel is six feet long and must be delivered on a pallet at around US \$250. A Pronghorn Modular Front End can be sent in three boxes via Fed Ex ground for about \$75 total. Another advantage is Pronghorn's no-modification installation system that reduces or even eliminates labor costs. Hermann credits being able to use CAD files supplied by the auto-makers directly in Cobalt to design one of the few "no-cut no-drill" bumpers available on the market. Finally, aluminum doesn't rust on salty winter roads.

Hermann says Cobalt's precision sped Pronghorn's development process tremendously, allowing them to go from specification to final prototype in seven to eight weeks. Its ease of use allows him to design with confidence without thinking about how to run the software. Hermann tells us:

"It was really the combination of the compatibility with the Macintosh platform and the ease of use. Cobalt is so fast and so easy to use that I think it gives us a huge advantage."

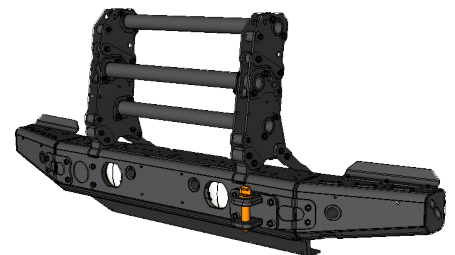
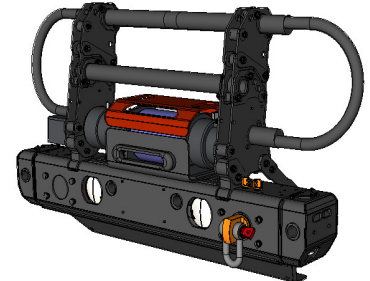

Two of 18 configurations of Pronghorn's Modular Front End System rendered in Cobalt CAD and 3D modelling software.



Working in the real world.

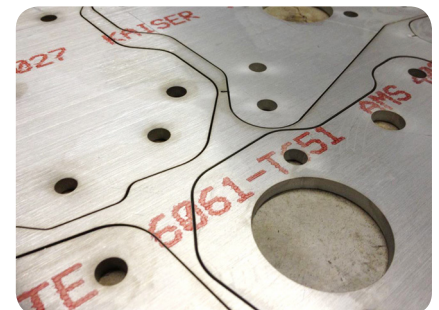

Aluminium sheets for Pronghorn's multiple configurations are laser and water jet cut according to Cobalt drawings.

Continued...

Story Update

With the success of the Modular Front End System for the Jeep, Pronghorn turned to the Toyota Tacoma, another vehicle popular with the overland and expedition crowd. Utilizing the huge time investment in the first platform, Pronghorn easily translated their system to the new vehicle. Hermann tells us that the most labour-intensive part was creating a CAD model of the Tacoma frame and bodywork since Toyota wouldn't supply the digital files. He says:

“While the Jeep system took us two years to develop, it took us two and a half months to translate the Jeep system in Cobalt over to the Toyota Tacoma. It was so easy. It was just a matter of getting into Cobalt and moving pieces around.”

Hermann continues to marvel at the efficiency of using precision 3D models created in Cobalt for high-fidelity rapid prototypes.

“I’m still amazed that I can send an STL file off and a week later I get a big chunk of metal that’s folded and welded and powder coated, and it’s here on my desk. And it looks fantastic. Twenty years ago we couldn’t have pulled that off.”

They are applying their hard-won victories in engineering, manufacturing and finding suppliers to other platforms as well. In addition to the Jeep and the Tacoma, Pronghorn has Modular Front End Systems in the works for the Toyota Land Cruiser, the Land Rover Defender and the Mercedes Geländewagen. These new markets are projected as excellent revenue multipliers to their bottom line.

In the process of translating the Front End System to the Tacoma, Pronghorn maintained their reputation for, as Hermann puts it, “taking the traditional off-road mentality and throwing it out the window.” For the Tacoma they introduced a low-mount recovery winch. By mounting the winch as low and as close as possible to the suspension system they solved a number of issues that greatly impact the truck’s handling, especially on soft surfaces.

But in the process, Hermann learned first hand about consumer pushback on conventional ideas by being on the innovative side of the equation. The concept of responsive handling is rather alien to those preferring trucks to sports cars. He tells us, “We can tell that it’s a good idea because we’re getting just as many people flaming us for it as people screaming how much they like it. I know when we’ve ruffled that many traditional feathers, I must be doing something right.”



Pronghorn easily translated their Modular Front End System from the Jeep JK (above) to the Toyota Tacoma (below) using Cobalt CAD and 3D modelling software.



The translation between vehicles, from design to prototype, took less than three months.



Pronghorn’s low-mount winch for the Tacoma.

Background/Contact

For more details on this project contact:

Trey Hermann
Pronghorn Overland Gear

(210) 859-6981

trey.hermann@pronghorngear.com

www.pronghorngear.com