

# The Design Explorer

## The Ashlar-Vellum User Newsletter

Third Quarter, 2008

### Graphite v8 Service Pack 1 Released



Three cheers! Service Pack 1 for Graphite v8 is now released.

Ashlar-Vellum president, Robert Bou, commented, "This Service Pack delivers significantly upgraded AutoCAD interoperability along with further improvements to our PDF export. This one-two punch further enables

seamless and continuous cross-team communications, a key component of Ashlar-Vellum's Organic Workflow<sup>TM</sup>."

The highlights of Graphite v8 SP1 include:

- Improved DWG/DXF translation including import of AutoCAD layouts with their views into Graphite sheets.

- Improved PDF smart-data export including support for more fonts and line weights.
- Support for AutoCAD DWG/DXF 2008.
- Improved printing of diagonal lines (Mac).
- Optimization for the Intel Mac with a performance increase of 3X on zoom, pan and selection functions, and 2X for file loading under Leopard.

This free update is available to everyone on Graphite v8 including Ashlar-Vellum Cobalt and Xenon users with courtesy licenses to Graphite v8.

To download the update, go to [www.ashlar.com/v8](http://www.ashlar.com/v8).

### Cobalt, Xenon & Argon v8 Service Pack 1 Update

Cobalt, Xenon and Argon v8 SP1 is now in final beta. This version includes:

- Optimization for Intel Mac.
- AutoCAD 2008 DXF/DWG support.
- Advanced hole creation and drill access.
- Direct support for imprinting profile sketches onto surfaces and solids to create surface subdivisions.
- Enhanced lathe tools that support non-planer profiles.

- Colours assigned for each face.
- Materials assigned for each face.
- ClarisCAD import.
- Scores of minor bug fixes.



## Nisha Patel Named Director of Customer Service

Nisha Patel is being promoted to Director of Customer Service where she will be in charge of expanding our customer service coverage hours, including email and telephone support for registration codes, by

establishing representatives in various times zones around the globe. Nisha's mix of technical and people skills have made her a favourite among our customers. Now she will be developing those skills in others.



## Check Web for Update

Please make sure that you are using the latest version of the software to which you are entitled.

- For Cobalt Xenon or Argon v8 owners: SP0 Build 824 (Win) or 824b (Mac).
- For Cobalt, Xenon or Argon v7 owners: SP2 Build 616.
- For Graphite v8 owners: SP1 Build 840 (Win) or 841 (Mac).
- For Graphite v7 owners: SP3 Build 788.

Using the latest builds solves a number of issues that you might encounter.

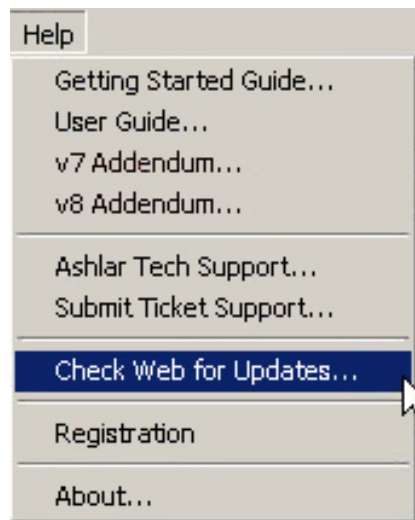

To download the latest build go to **Help>Check Web for Updates**. You might need your serial number and registration code.

If you do not have this command, you know your software is very old. To upgrade to v8, contact your reseller or Ashlar-Vellum, or purchase through our web store. To stay on v7 and download the last build to which you're entitled, go to [www.ashlar.com/v7](http://www.ashlar.com/v7) and follow the prompts to the correct product for your operating system. Your serial number and registration code are required.

## RCSI to License Graphite Custom

Ashlar Incorporated has signed an agreement with Roofing Contractor Solutions Inc. to license Ashlar-Vellum Graphite Custom software. RCSI will use Graphite Custom as the basis on which to develop a new estimating application to assist the building industry. Bill Sullivan, CEO of RCSI,

commented that, "We examined a variety of CAD platforms on which to build our software and decided that Graphite's ease of use, flexibility and power were unmatched by any other." Ashlar-Vellum's President, Robert Bou, had this to say, "RCSI's needs match exactly what we have to offer: a powerful CAD package

with an easy user interface that is highly customizable, allowing them to create a small footprint application that directly addresses their customers' needs." Both companies are looking forward to a long and prosperous working relationship.

## Improved PDF Export in Graphite v8 SP1

Why is Ashlar-Vellum PDF export so important?

The traditional way to get something in PDF (Adobe's Printed Document Format) is to Print to PDF through the operating system.

This tessellates the curves, turning them into millions of tiny line segments that emulate arcs or splines. It also loses all smart data such as layers. This is fine if the only goal of the PDF is for display and printing purposes.

On the other hand, if the goal is to change or enhance the drawing using other software, such as Adobe

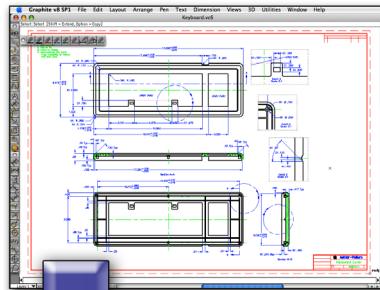

*Graphite*

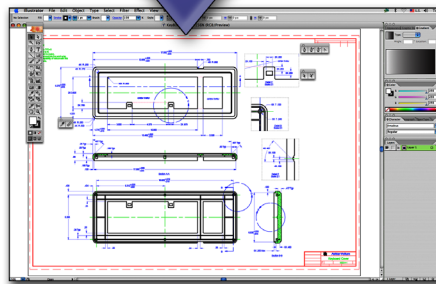
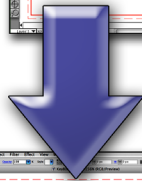

*Adobe Illustrator*

Illustrator, a smarter version of the data vastly simplifies the process. By using Graphite's Export to PDF command through the Export menu, Graphite creates an entity that's as close as possible to the original while still maintaining visual fidelity. Take this smarter set of data into Illustrator for easy manipulation of arcs and splines, not a bunch of tiny line segments.

This month's Service Pack 1 update to Graphite v8 includes enhanced support for a variety of line weights and a greater array of supported fonts for PDF export.

## Diagonal Line Issue Solved



Developers Vladislav Antonenko (left), Geogriy Sokolov and Andrew Patlan solve the diagonal line issue.

Three cheers to our Graphite team, Georgiy Sokolov, Vladislav

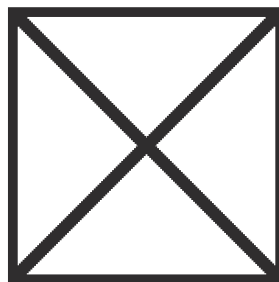

Previously, diagonal lines appeared thicker.

Antonenko and Andrew Patlan, who have done what no developers at Ashlar-Vellum have done before. They solved the Graphite issue of diagonal lines appearing thicker than vertical or horizontal lines of

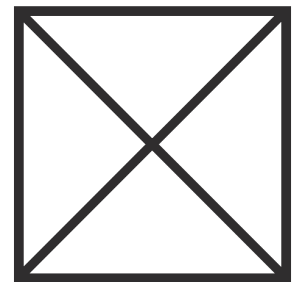

Now, all lines of the same pen weight display correctly.

the same pen weight on Mac under OS X. Previous developers said it couldn't be done, but our team proved them wrong. This enhancement to diagonal lines is part of the Graphite v8 SP1 release.

## Why won't Ashlar-Vellum Open my old Mac File?

In recent years Apple has been phasing out support for certain characters in file and folder names. During this time, in order to remain compatible with Apple, Ashlar-Vellum has been evolving Cobalt, Xenon, Argon and Graphite to use the new Apple file functions that do not support these old characters.

For example, a file named "table 8/19/08.co" or "table 8:19:08.co" could be opened in Cobalt v7 but cannot be opened in Cobalt v8.

When using OS 9 and older operating systems, the slash (/) and the colon (:) were both legal.

Now, under OS X they are no longer supported by Apple, nor by us.

Therefore, use **ONLY** the following characters in naming files or folders:

**a-z**

**A-Z**

**0-9**

- hyphen
- \_ underscore
- ( ) parentheses
- period

All other characters may or may not work depending upon thousands of different circumstances.

Also note that while a period may be used anywhere in a Mac file name, under Windows it is ill-advised except at the end of the file name to designate the file type, such as .co, .jpg, or .pdf. If you're a Mac user trying to communicate cross-platform with those on Windows, this is especially important to remember.

So, to resolve the question, if you simply rename the files mentioned above to "table 8\_19\_08.co" or "table 8-19-08.co" they will open just fine.

## SCORE! Information Update

Our long-time OEM and business partner, Dimensional Impressions, now Esko Graphics, has announced the discontinuation of SCORE! software for the packaging and display industry. The Score plug-in for Vellum was originally developed by Ashlar in collaboration with Mike Collins and sold to DI.

If you're a SCORE! customer looking to update, there are two options available that use Graphite as the CAD engine. Both support Mac and Windows.

### AlphaCorr

AlphaCorr, based in Austin, Texas, has recently acquired Mike Collin's company, RulesSoftware. RulesSoftware has everything

you need and requires no new training for SCORE! users.

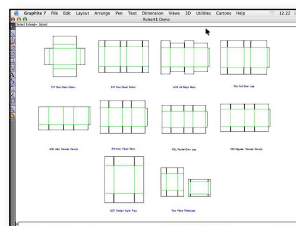

See more at [www.alphacorr.com](http://www.alphacorr.com).

### Comnet

Comnet, based in Kobe, Japan, offers Box Vellum-Graphite. This software also features everything needed for rapid box design.

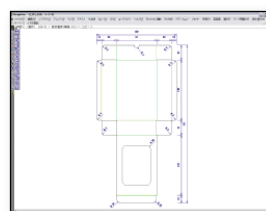

See more at [www.comnet-network.co.jp/eng/index.html](http://www.comnet-network.co.jp/eng/index.html).

## Graphite Quick Reference Card Available

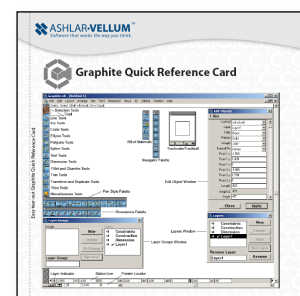

A Graphite Quick Reference Card has been created and is available for download from our website under **Support>Documentation**. This reference fits on both sides of a single sheet and is a handy guide to remembering Graphite shortcuts for those who are new to the software.

## Why is my Drawing a Tiny Speck?

Occasionally our tech support line gets a desperate call saying, "When I open my drawing, it's become a tiny speck!"

As Robert Bou, president of Ashlar-Vellum, explains it, "You've probably got some space junk floating somewhere in the outer edges of your drawing universe."

The procedure to locate and collect this is somewhat

different, depending on which program you're using.

### For Cobalt, Xenon or Argon:

1. With the offending file open, draw a selection box around the speck that is your drawing. Using the Show/Hide dialog box select Hide.
2. Now Zoom All to zoom up on whatever is lurking in the outer edges of the drawing and determine its value. It could be anything from an important parent part from your drawing to a piece of junk that's seemingly appeared from nowhere.

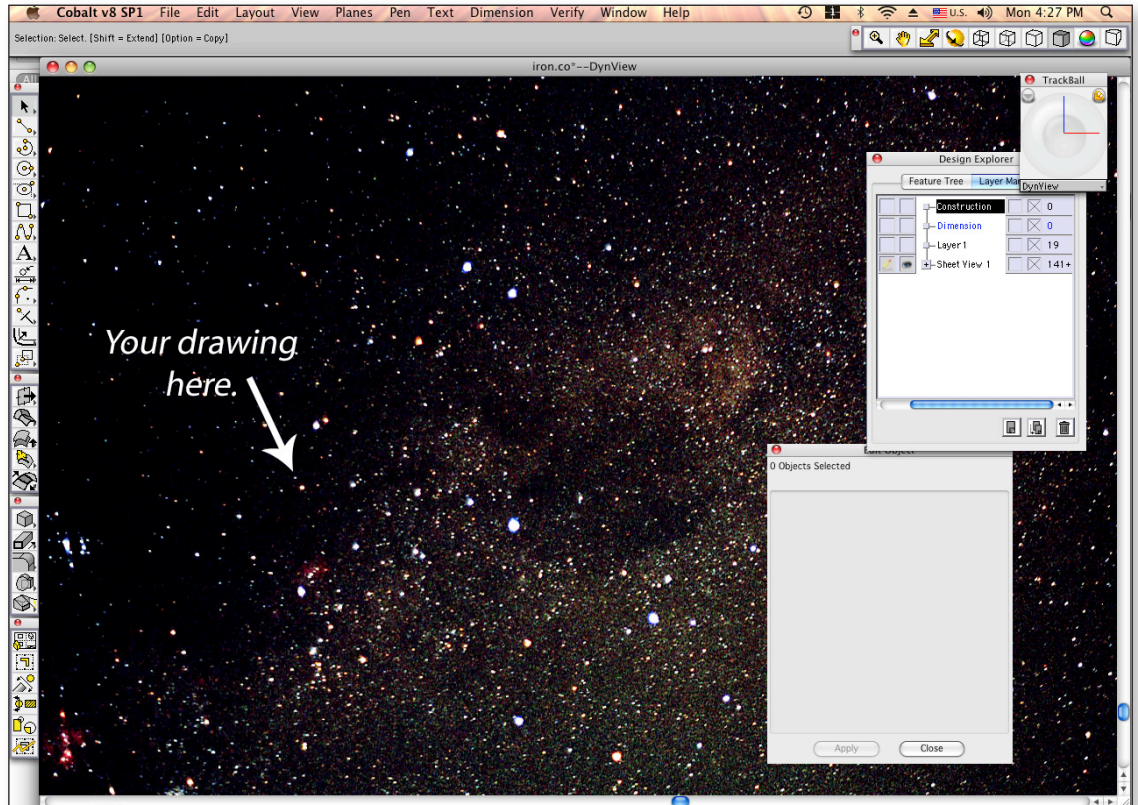

3. If it is a parent part in Cobalt or Xenon, don't delete it. Click on the object in the History Tree and you'll probably see a transform command that was used to boost it into orbit. If it is part in Argon, manually move it back into position. If it is actually junk, just delete it.
3. Now Show All and Zoom All. This should fill your screen with the known drawing.
4. If your drawing is still a speck, repeat the process one or more times, deleting or moving things that have flown to the outer quarters of the drawing space.

### For Graphite:

1. Working with a COPY of the drawing, delete the speck in the of the drawing universe.
2. Then you'll need to find the relative coordinates of the offending junk or stray parts by zooming up on each of the four quadrants of the drawing area.
3. When you've located these and noted their whereabouts, open your original drawing and delete the junk or move the parts back into position.



## Rather Be Fishing?

*Cabela's, the world's foremost outfitter for hunting, fishing and outdoor gear, has made quality products one of its core values since its inception in 1961, when the company was started on Dick and Mary Cabela's kitchen table. Today, the nation's largest direct marketer of outdoor outfitting merchandise, it ships over 7 million customer orders every year through its catalogues and web site, and completes in excess of 6 million sales transactions through its nine mega-store retail outlets.*

Because of the rigors of outdoor outfitting, and the superior quality demanded by their customers, Cabela's fishing gear designer, Chuck Villarreal, is always looking for ways to improve their product line and get new designs to market faster.

Classically-trained, Villarreal wasn't thrilled about moving to CAD from his t-square and drafting board. He found it cumbersome and unwieldy to accomplish his designs...until he found Ashlar-Vellum™ Graphite™.

***"This program was so simple to learn I was productive in two days. Later, after attending training I became a rocket."***

Villarreal found Graphite to be a perfect match for his job of writing technical specifications and developing new products for the Fishing, Marine and Hard Goods divisions at Cabela's. As one person trying to keep up with literally thousands of items, he requires a program that gets the job done quickly, with the highly accurate, detailed manufacturing drawings he demands. Says Villarreal, "Graphite's 2D and 3D wireframe capabilities, along with the many features and file translation capabilities, are perfectly suited to allow me to do just that."

Graphite's unique user interface allows Villarreal to think through his ideas as he works, perfecting the design without worrying about how to run his software. All other CAD packages offer far less flexibility in moving from concept through completed drawing. Because of Graphite's supreme accuracy as a CAD package, Villarreal can send his designs directly to manufacturing with confidence.



Chuck Villarreal, fishing gear designer for Cabela's, lands an over 30 pound Mahi Mahi using gear designed in Graphite.

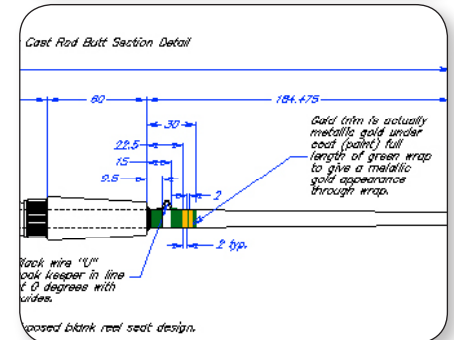
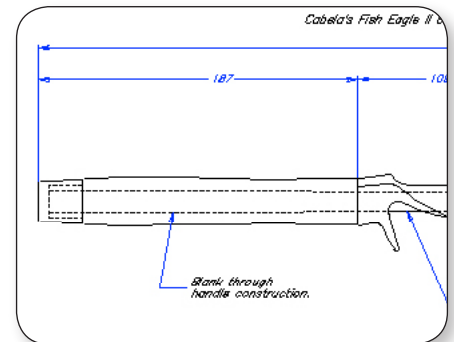

Details of a precision drawing for a new fishing pole designed by Chuck Villarreal in Graphite.

### Background/Contact:

For more details on this project contact:

**Cabela's**  
One Cabela Dr  
Sidney, NE 69160

**Phone:** 308-254-7992

**Email:** cvillar@cabelas.com